

MACHINE SOLUTIONS INC.



USER MANUAL

BEAHM DESIGNS SPLIT DIE THERMAL BONDER MODEL 220-B



BEAHM
DESIGNS

Machine Solutions Inc. 2951 W. Shamrell Blvd. Flagstaff, Arizona 86005 USA

Tel: 928-556-3109

• Fax: 928-556-3084

Service@machinesolutions.com

• www.machinesolutions.com

The Machine Solutions Inc. products shown and described in this catalog may be covered by one or more of the following US Patents: #6,629,350, #6,968,607, #6,925,847, #6,988,881, #6,931,899 and #7,069,794. Other US and International Patents Pending.

Machine Solutions, MSI, and 220B are trademarks or service marks of Machine Solutions Inc.
Copyright (©) Machine Solutions Inc. All Rights Reserved.

Product images are representative of standard equipment offerings and may differ from delivered equipment.

Table Of Contents

List of Figures.....	5
List of Tables.....	5
Welcome.....	6
Machine Description	6
Safety.....	7
User Alerts	7
Contents	8
Installation.....	8
System Controls And Features	9
<i>Vee-Guide Attachment (Optional Equipment)</i>	11
<i>Cutter (Optional Equipment)</i>	12
<i>Control Box Setup Changes</i>	12
<i>Cutting</i>	13
<i>Blade Switching</i>	14
<i>Process Development Parameters</i>	17
Parameter Settings.....	18
Temperature Controller	18
Pressure Regulator Setting.....	18
Cooling Air ON Toggle.....	18
Cooling Air Flow Adjust	18
Process Timer Setting.....	18
Omega Platinum Temperature Controller	19
<i>Adjusting Temperature on Temperature Controller(s)</i>	19
<i>Resetting the Temperature Controller</i>	19
Run process	20
Maintenance.....	21
<i>Cleaning</i>	21

<i>Preventative Maintenance</i>	21
<i>Fuse Replacement</i>	22
<i>Die Head Replacement</i>	23
Diagnostics and troubleshooting.....	26
Specifications.....	27
Critical parts.....	28
Customer support and satisfaction	29
Warranty and limitations	30
Appendix A	32
Temperature Controller Layout and Description of Button Actions	32
Auto Tune Temperature Controller(s).....	33
Changing Temperature Units on the Temperature Controller.....	37
Resetting the Temperature Controller(s) back to factory defaults.....	38
Resetting the Temperature Controller(s) back to MSI settings.....	39
Appendix B.....	49
Die Head Sizing	49

LIST OF FIGURES

Figure 1. Contents Included with the System.....	8
Figure 2. 220-B Split Die Thermal Bonder Front Panel.....	9
Figure 3. 220-B Split Die Thermal Bonder Back Panel.....	10
Figure 4. Vee Guide Attachment AC 226 Accessory.....	11
Figure 5. Cutter Accessory.....	12
Figure 6. Knob used to set cut distance	13
Figure 7. V-Block in lock position	13
Figure 8. Release button.....	14
Figure 9. Blade in retracted position.....	14
Figure 10. Removing blade holder	15
Figure 11. Blade holder	15
Figure 12. Reinstalling blade holder.....	16
Figure 13. Blade holder securement detail	16
Figure 14. Flow control.....	17
Figure 15. Removing Fuse Insert	22
Figure 16. Fuse Replacement	22
Figure 17. Fuse Insert Replacement.....	23
Figure 18. Screws on the Left Side of the Safety Cover.....	23
Figure 19. Screws on the Right Side of the Safety Cover	24
Figure 20. Screws at the Base of the Die Head.....	24
Figure 21. Die Head with Thermocouple and Set Screw	25

LIST OF TABLES

Table 1. Control and Display Functions (Front).....	9
Table 2. Control and Display Functions (Back)	10
Table 3. Diagnostics and Troubleshooting	26
Table 4. System Specifications	27
Table 5. Critical Parts List.....	28

WELCOME

Machine Solutions, Inc. (MSI) would like to take this opportunity to thank you for purchasing your new 220-B Split Die Thermal Bonder machine. At MSI, we are dedicated to bringing innovative process development solutions to both medical device and nonmedical organizations. MSI looks forward to helping your organization provide life-improving devices to your customers, today and tomorrow.

This machine has been thoroughly tested to ensure it meets the highest quality standards and is ready for immediate integration into your production process. Your machine has undergone functional and safety testing to ensure it meets all manufacturing specifications.

MACHINE DESCRIPTION

The Beahm Designs Inc. Model 220-B Split Die Thermal Bonder is a system designed for the purpose of performing high quality heat welds and balloon bonds. This unique and simple die head design of the Beahm Designs Split Die Thermal Bonder provides a low-cost quick tool alternative to RF die bonding. The three-parameter operation is easy to set-up and use and simplifies system calibration and process validation. Upgraded options such as vision system and vee-guide attachment further increase versatility and functionality. This system provides you with fast, highly repeatable bonds. Allows you to perform highly precise bonds for demanding applications such as short balloon bonds and ultra-smooth lap & butt welds. Adjustable clamp pressure varies compression force on joint. The ultra-compact design provides you with greater workspace.

SAFETY

- Place the system on a level, sturdy surface at an ergonomically viable height for the user.
- Use of eye protection when working with compressed gases and heated materials is advised.
- Connect the electrical umbilical to the die base unit.
- Connect the power cord to the main control unit.
- Connect the air supply to the system and then to a clean, dry, and filtered compressed air source.
- The maximum observed Sound Pressure Level is below 70 dBA.
- Hot die jaws will become hot during operation and, depending on temperature set-point, can cause severe skin burns if contact occurs.



Caution: high voltage. Remove power and use safety precautions when servicing.



Caution: hot surface. Contact may cause burn. Allow to cool before servicing.



Caution: pinch point. Keep hands and body parts clear while in operation.

USER ALERTS

Do not use or otherwise operate the machine in any manner other than that in which it is explicitly intended. Examples: Do not attempt to sit on or climb on the equipment, do not place heavy objects or containers of liquid on the machine, do not to insert any foreign objects into the machine and do not attempt to bypass any guards.

Note: The equipment is not for use with materials that can decompose or ignite below the maximum operating temperature of the machine. Hazards are materials that outgas hazardous substances and or ignite. (260°C/500°F).

Note: This equipment is not for use in an ATEX environment.

CONTENTS

Included with the system are the following contents:

1. IEC Power Cord
2. Foot Pedal
3. Air Pneumatic and Thermocouple Umbilical Cable
4. Heater Power Cord



Figure 1. Contents Included with the System

INSTALLATION

1. Place the system on a level, sturdy surface at an ergonomically viable height for the user.
2. System power is in the OFF position.
3. Connect the heater power cord, thermocouple umbilical cable, and air hoses between the main control unit and die base unit.
4. Connect the air supply to the system and then to a 100-125 PSI clean, dry, and filtered compressed air source.
5. Connect the main AC power to the power entry module on the rear panel.
6. Connect the foot pedal to the rear panel of the main control unit.

SYSTEM CONTROLS AND FEATURES

Located on the front and back panels of the Split Die Thermal Bonder are the following controls and/or displays and their functions:

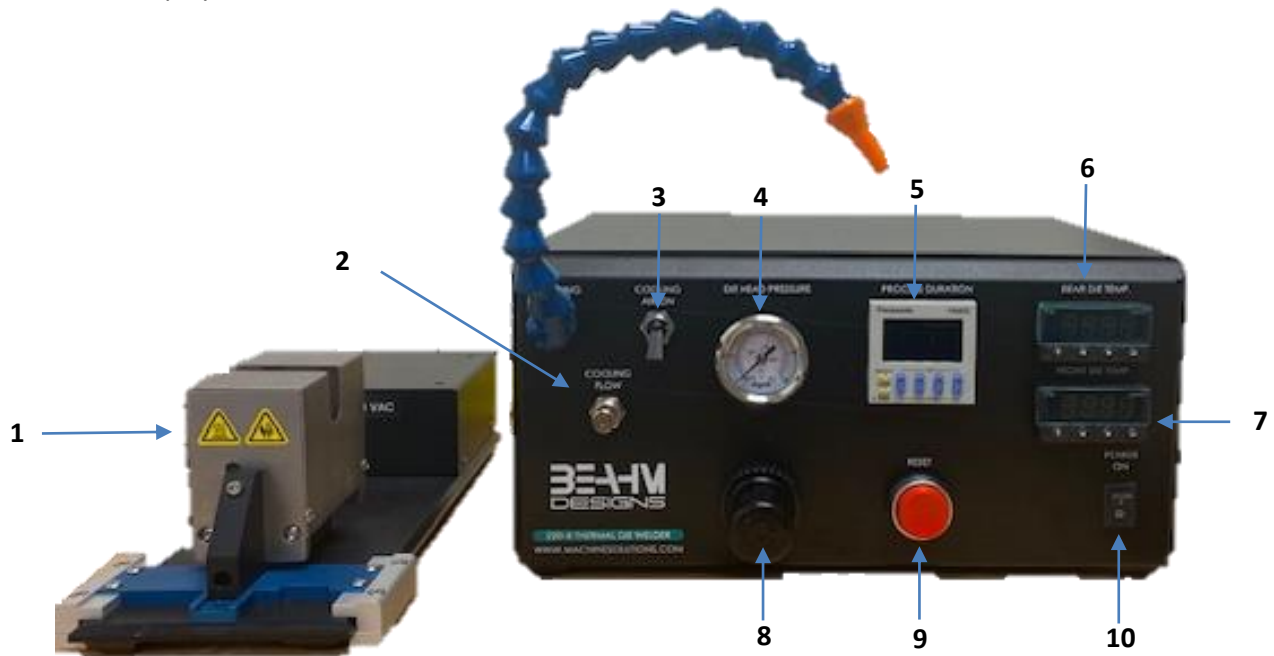

Figure 2. 220-B Split Die Thermal Bonder Front Panel

Table 1. Control and Display Functions (Front)

Item	Function
1	Thermal processing of product.
2	Controls cooling air flow rate.
3	Toggles cooling air on/off.
4	Displaces die head gripper pressure.
5	Set timer to desired duration in seconds.
6	Controls the temperature of the rear die head.
7	Controls the temperature of the front die head.
8	Regulates the pressure to the die head gripper.
9	Timer resets and starts again.
10	Toggles system power and air on/off.



Figure 3. 220-B Split Die Thermal Bonder Back Panel

Table 2. Control and Display Functions (Back)

Item	Function
1	Connects to power cord
2	Protects power distribution
3	Supplies air to machine.
4	Allows connection to foot pedal.
5	Supplies air from main control unit to die base unit.
6	Supplies signal from thermocouples to main control unit.
7	Delivers power from main control unit to heaters on die base unit.

Vee-Guide Attachment (Optional Equipment)

Vee-Guide Attachment AC 226 Accessory Upgrade available, (See Figure 4. below). For additional information on Beahm Designs, Split Die Thermal Bonder Upgrades, please visit <http://machinesolutions.com/our-products/>

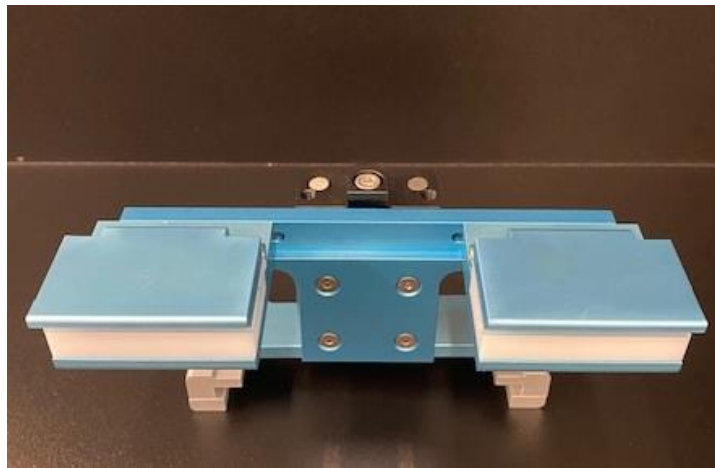

Figure 4. Vee Guide Attachment AC 226 Accessory

Cutter (Optional Equipment)

The cutter accessory for the 220B makes accurate cuts of thermoplastic material at repeatable lengths up to 280mm long. Temperature control of the blade creates consistent cutting results at temperatures of up to 500° F.



Figure 5. Cutter Accessory

Control Box Setup Changes



- Temperature Controller 2 and the associated TC2 are not used for the operation of this accessory. Only connect TC1 to the back of the cutter accessory.
 - Refer to Page 18 for information on the Omega Platinum Temperature Controller.

Cutting

Ergonomic notice: Do not use cutter for an extended period without breaks.

- Using knob above v-block, set cut distance.

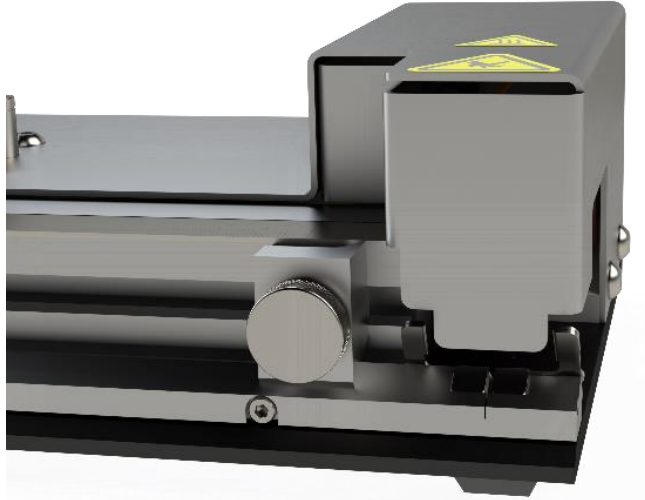

Figure 6. Knob used to set cut distance

- Flip up product clamps.
- Lay product in v-block.
- Flip down product clamps.
- Push v-block in to lock position.



Figure 7. V-Block in lock position

- Actuate 220B via the foot switch.
- Press release button.

- The v-block should return to start position.

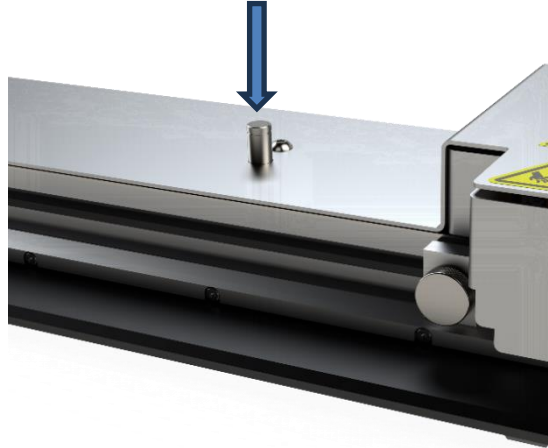

Figure 8. Release button

- Remove product from v-block.

Blade Switching

Note: The blade and surrounding metal components can and will discolor at temperatures above 400°F/200°C.

- Ensure that blade holder is cool.
- Unplug all connections on the back of the accessory.
- Blade can only be changed when it is in the retracted position.



Figure 9. Blade in retracted position

- Reach in and unscrew the knob by turning counter-clockwise.



Figure 10. Removing blade holder

- Pull the blade holder out.



Figure 11. Blade holder

- Reinstall blade holder in it's position, screwing the knob in a clockwise motion.

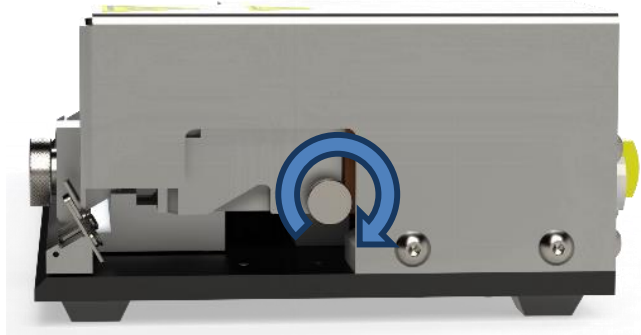

Figure 12. Reinstalling blade holder

Note: Knob only needs to be finger tight.

- Ensure that angle on operator side of machine nests with blade holder.

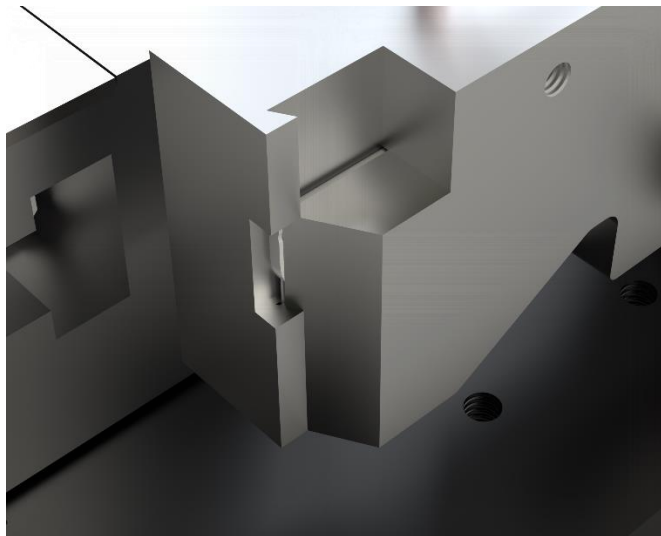

Figure 13. Blade holder securement detail

Process Development Parameters

Temperature

- Controlled with “Rear Die Temperature” temp controller.

Time

- Controlled with timer on front of 220B.

Pressure

- Controlled with regulator on front of 220B.

Speed

- Controlled with flow control. Refer to **Figure 14. Flow control**.

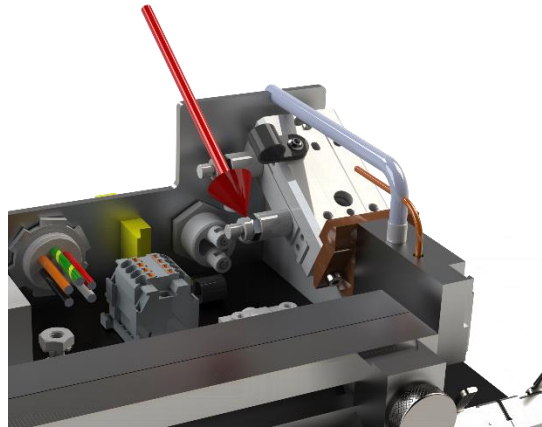

Figure 14. Flow control

PARAMETER SETTINGS

Temperature Controller

- Refer to page 19, Omega Platinum Temperature Controller.

Pressure Regulator Setting

- Rotate the regulator knob clockwise to increase air pressure, and counterclockwise to decrease air pressure output to the die head actuation cylinder.

Cooling Air ON Toggle

- Place toggle in the up position for cooling air On, and toggle down for cooling air Off.

Cooling Air Flow Adjust

- Rotate the Cooling Flow valve counterclockwise to increase the cooling air flow, and clockwise to decrease the cooling air flow.

Process Timer Setting

- Depress the upper half of the blue rocker buttons to increase time duration, depress the lower half of the blue rocker button to decrease the time duration. Depress the timer reset button for at least 1.0 seconds to accept the new value.







OMEGA PLATINUM TEMPERATURE CONTROLLER

ATTENTION: PRIOR TO MAKING ADJUSTMENTS, PLEASE SEE THE APPENDIX FOR FURTHER INFORMATION ABOUT THE OMEGA PLATINUM TEMPERATURE CONTROLLER. THE TEMPERATURE CONTROLLERS HAVE BEEN PRE-PROGRAMMED.

Adjusting Temperature on Temperature Controller(s)

Use the PRoG (Programming Mode) Menu

Level 2	Level 3	Level 4	Level 5	Level 6	Level 7	Level 8	Notes
SP1	_____						Process goal for PID

	Note: If not at Level 1, push the  button to get to that level. Level 1 = INIT, PRoG, and oPER
	Navigate to PRoG (Programming Mode).
	Select PRoG .
	Navigate to SP1 (Setpoint 1 parameter).
	Select the SP1 .
	Set the desired temperature.
	Confirm the value. The heaters will ramp to correct temperature.

Resetting the Temperature Controller

Refer to Appendix A for resetting the temperature controller and all temperature control settings.

RUN PROCESS

1. Assemble components to be bonded over mandrel(s).
2. Measure bond length, tubing overlap or balloon sleeve length.
3. Position the protective sleeve over the bond area.
4. Measure the O.D. of the protective sleeve.
5. Set timer to desired duration in seconds.
6. Position components to be bonded within thermal jaws.
7. Depress footswitch.
8. To cool assembly when cycle is complete, position the heated area at the tip of the cooling air nozzle and toggle the cooling air switch to the "on" position.

MAINTENANCE

Note: Ensure the machine is unplugged for any servicing or maintenance work.

Note: Perform these steps **ONLY** when the machine is at room temperature.



Caution: pinch point/crush hazard. Keep fingers, hands, and clothing clear of moving parts.



Caution: hot surface. Contact may cause burn. Allow to cool before servicing.

Cleaning

1. Use 99% isopropyl alcohol to wipe down the outside of the machine. Do not attempt to clean the inside of the machine. The machine should not be washed down.
2. Cleaning should be with a soft dry cloth only.

Preventative Maintenance

1. Check the power cable for damage every 12 months and replace as needed.
2. Check setting of pre-regulator every 12 months.

Fuse Replacement

Note: Figures are reference only. They may vary depending on machine model.

1. To replace a blown fuse, turn off machine power by unplugging the power cord from the machine.
2. Remove the insert.
 - a. Using a flat head screwdriver, push the fuse insert inward and turn counterclockwise to release.



Figure 15. Removing Fuse Insert

3. Fuse replacement.
 - a. Remove the old fuse and replace it with the new one.



Figure 16. Fuse Replacement

4. Insert replacement.
 - a. Using a flat head screwdriver, seat the insert by pushing inward and turning clockwise.



Figure 17. Fuse Insert Replacement

Die Head Replacement

Caution: Ensure the die heads are cooled to within 15°F of ambient temperature before proceeding with installation or replacement.

1. Remove the safety cover.
 - o Remove two screws from the left side of the safety cover.

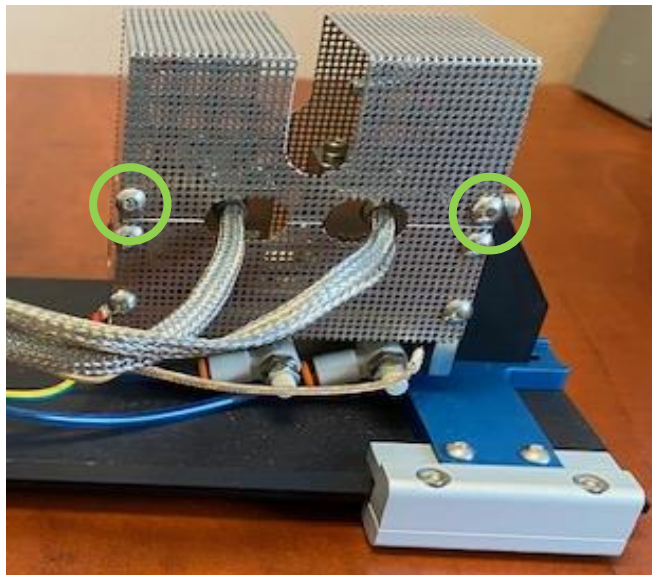

Figure 18. Screws on the Left Side of the Safety Cover

- Remove two screws from the right side of the safety cover.

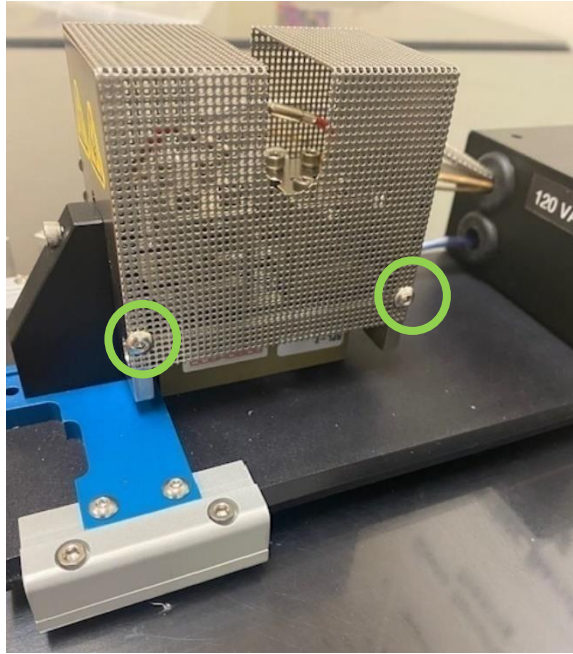

Figure 19. Screws on the Right Side of the Safety Cover

2. Remove the four screws at the base of each die head.

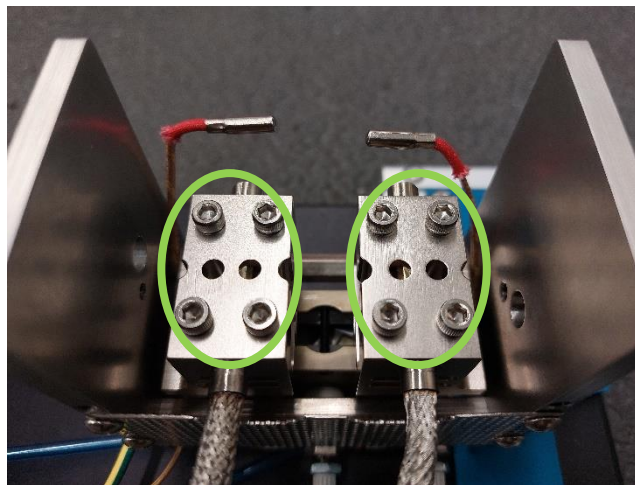

Figure 20. Screws at the Base of the Die Head

3. Position new die heads in place, install the four screws at the base of each die head. Do not overtighten the screws.

4. Install the thermocouple in the rear of each die head and gently tighten the set screw to hold them in place. **DO NOT OVER TIGHTEN.**

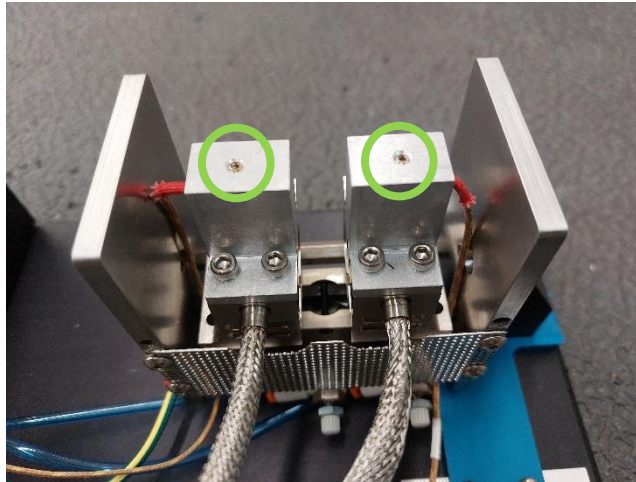

Figure 21. Die Head with Thermocouple and Set Screw

5. Reinstall the eight screws previously removed in Step 2.
6. Reinstall the Safety Cover and four screws previously removed in Step 1.

DIAGNOSTICS AND TROUBLESHOOTING

Table 3. Diagnostics and Troubleshooting

Issue	Possible Causes	Solution
Temperature not stable	<ul style="list-style-type: none"> • Split Dies replaced • Thermocouple loose 	<ul style="list-style-type: none"> • Auto-tune (MSI recommends process auto-tune @ temperature.) • Re-install thermocouple
“Open” flashing on temperature controller	<ul style="list-style-type: none"> • T.C sensor break 	<ul style="list-style-type: none"> • Bad thermocouple • Verify complete T.C. path
No heat at Dies	<ul style="list-style-type: none"> • Defective heating element • Defective power control 	<ul style="list-style-type: none"> • Replace heating element • Contact Beahm Designs
.Err code in display	<ul style="list-style-type: none"> • Temperature controller • Software failure 	<ul style="list-style-type: none"> • Replace temperature controller
System will not power on	<ul style="list-style-type: none"> • IEC power cord not fully connected • Fuse needs to be replaced 	<ul style="list-style-type: none"> • Verify installation • Replace fuse

SPECIFICATIONS

Table 4. System Specifications

Description	Range	Resolution	Accuracy
Temperature	200-500° F	0.1°F/°C temperature; 10 µV process	+/- 0.03% F.S.
Air Flow	20-50 SCFH	5.0 SCFH	+/- 4% F.S.

Facilities Requirements

- Voltage: 120-240 VAC, 50/60 hz
- Wattage: 10 amps (500 watts)
- Compressed Air: 100-125 psi, clean dry compressed air

CRITICAL PARTS

For replacement or spare parts, please contact us at service@machinesolutions.com, or call 928-556-3109.

Table 5. Critical Parts List

Part Number	Description	Quantity
120V – 1153590-001	HEATER, CARTRIDGE	1
220V – 1157788-001		1
1143133-001	THERMOCOUPLE, K TYPE	1
3054593-101	BLANK DIE HEAD, PAIR	1
1350774-001	PRESSURE GAUGE	1
1161899-001	CONTROLLER, TEMP, OMEGA	1
110092-005	FUSE	2

CUSTOMER SUPPORT AND SATISFACTION

Machine Solutions Inc. is proud of the advanced engineering and quality construction of each piece of equipment that we build. It is our goal to provide equipment that exceeds the expectations of the customer. By implementing the highest standards and applying our experience to provide a quality product, we maintain an ongoing, positive working relationship with all our customers.

Machine Solutions Inc. welcomes your comments and inquiries about our products and services.

Machine Solutions Inc.
2951 West Shamrell Blvd., Suite 107
Flagstaff, AZ 86005

Phone: 928-556-3109
Fax: 928-556-3084
E-Mail: Service@MachineSolutions.com

WARRANTY AND LIMITATIONS

General Warranty

Machine Solutions Inc. (MSI) warrants its products to be free from defects in material and workmanship in normal every day use and service for a period of one year from the date of shipment from the factory in Flagstaff, Arizona. MSI's obligation under this warranty shall be limited to the repairing or replacing of the product or parts thereof which upon MSI's inspection reveals them to be defective. MSI reserves the right and option to refund the purchase price in lieu of repair or replacement upon evaluation of the returned original part. Modifications, misuse, attempted repairs by others, improper calibration or operation shall render this guarantee null and void. MSI MAKES NO OTHER WARRANTY REGARDING THIS PRODUCT, INCLUDING ANY EXPRESS OR IMPLIED WARRANTY. SPECIFICALLY, THERE IS NO WARRANTY OF MERCHANTABILITY OF THIS PRODUCT OR OF THE FITNESS OF THE PRODUCT FOR ANY PURPOSES. THE SUITABILITY OF THIS PRODUCT FOR ANY PURPOSE PARTICULAR TO THE CUSTOMER IS FOR THE CUSTOMER, IN ITS SOLE JUDGEMENT, TO DETERMINE. MACHINE SOLUTIONS, INC. ASSUMES NO RESPONSIBILITY FOR THE SELECTION OR USE OF THIS PRODUCT BY CUSTOMER. This product has not been tested or approved by the U.S. Food and Drug Administration or any other agency of the U.S. government. This product is not a consumer product as that term is defined in the Magnuson-Moss Warranty – Federal Trade Commission Improvement Act, 15 U.S.C. § 2301 et seq.

Software License

By using this equipment, and/or installing or using any of the software associated with the same, you indicate your acceptance of each of the terms of this license. Upon acceptance, this license will be a legally binding agreement between you and MSI. The terms of this license apply to you and to any subsequent user of the software. If you do not agree to all of the terms of this license (i) do not install or use the software and (ii) return the equipment and the software (collectively, equipment), including all components, documentation and any other materials provided with the equipment, to MSI. The software includes associated media, any printed materials, and any on-line or electronic documentation. Software provided by third parties may be subject to separate end-user license agreements from the manufacturers of such software. This license shall also apply to any updates, bug fixes, or newer versions of the software provided by MSI for use with this equipment.

You may: (1) Use the software only in connection with the operation of the equipment; (2) Transfer the software (including all component parts and printed materials) permanently to another person, but only if the person agrees to accept all of the terms of this license. If you transfer the software, you must at the same time transfer the equipment and all copies of the software (if applicable) to the same person or destroy any copies not transferred; and (3) Terminate this license by destroying the original and all copies of the software (if applicable) in whatever form.

You may not: (1) Loan, distribute, rent, lease, give, sublicense or otherwise transfer the software, in whole or in part, to any other person, except as permitted under the transfer paragraph above; (2) Copy or translate the User Guide included with the equipment; (3) Copy, alter, translate, decompile, disassemble or reverse engineer the software, including but not limited to, modifying the software to make it operate on non-compatible hardware; or (4) Remove, alter or cause not to be displayed, any copyright notices or startup message contained in the software programs or documentation

Title to the software, including the ownership of all copyrights, patents, trademarks and all other intellectual property rights subsisting in the foregoing, and all adaptations to and modifications of the foregoing shall at all times remain with MSI and its third party licensors, if any. MSI retains all rights not expressly licensed under this license. Except as otherwise expressly provided in this license, the copying, reproduction, distribution or preparation of derivative works of the software, or any portion of the equipment, is strictly prohibited. Nothing in this license constitutes a waiver by MSI of its rights under United States copyright law.

Protection of Intellectual Property

The equipment and its incorporated technology (collectively referred to herein as the Technology), is protected under issued and pending patents. The Technology is the valuable and proprietary technology, including trade secret technology, belonging to MSI. Much of the Technology is nonpublic and confidential. As our customer, you agree to further assist MSI in the protection of our intellectual property as follows: You agree to keep the Technology you receive confidential at all times, and shall not, without the prior written consent of MSI, disclose the Technology, in whole or in part, to any person outside of your company. You further agree that you shall not reverse engineer, disassemble, decompile or copy the Technology without the prior written consent of MSI.

In addition, you agree that the equipment will not be used to manufacture anything other than products in which you hold intellectual property rights free of infringement of others. You may not use the equipment to manufacture any product infringing on another's patented rights. By accepting and using the equipment, you agree to defend and indemnify Machine Solutions, Inc., its officers, directors, employees and agents, from and against any claims of infringement as a result of your use of the equipment.

Regulatory Matters

All equipment validations, product validation, final product QC testing and other testing required by the U.S Food and Drug Administration are the sole responsibility of the customer. Machine Solutions, Inc. shall have no responsibility or liability for the performance of any interventional product on which this equipment is used.

APPENDIX A

Omega Platinum Temperature Controllers

ATTENTION: The initialization portion of the Omega Temperature Controller(s) has been password-protected. Some reasons for this practice to be implemented are:

- Prevent unauthorized Access.
- Avoid Tampering.
- Mitigate user errors.
- User accountability.

For additional information, please contact service@machinesolutions.com

Temperature Controller Layout and Description of Button Actions

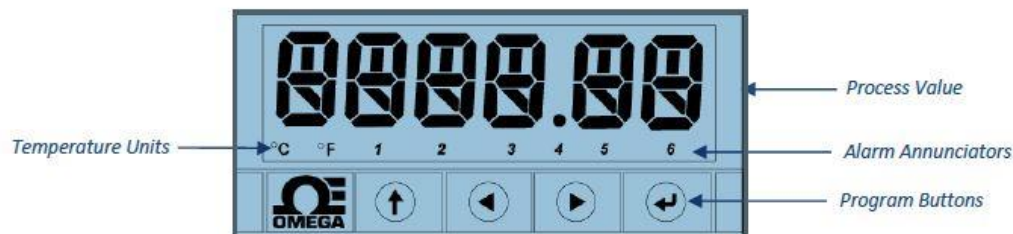





Figure A-1. Controller Layout

- 

The UP button moves up a level in the menu structure. Pressing and holding the UP button navigates to the top level of any menu (oPER, PRoG, or INIt). This can useful if you get lost in the menu structure.
- 

The LEFT button moves across a set of menu choices at a given level (up in the Section 4 menu structure tables). When changing numerical settings, press the LEFT button to make the next digit (one digit to the left) active.
- 

The RIGHT button across a set of menu choices at a given level (down in the Section 4 menu structure tables). The RIGHT button also scrolls numerical values up with overflow to 0 for the flashing digit selected.
- 

The ENTER button selects a menu item and goes down a level, or it enters a numerical value or parameter choice.

Figure A-2. Description of Button Actions

INIt	Initialization Mode: These settings are rarely changed after initial setup. They include transducer types, calibration, etc.
PRoG	Programming Mode: These settings are frequently changed. They include Set points, Control Modes, Alarms, etc.
oPER	Operating Mode: This mode allows users to switch between Run Mode, Standby Mode, Manual Mode, etc.

Figure A-3. Level 1 Menu

Auto Tune Temperature Controller(s)

Please note, the Omega temperature controllers have been auto tuned and are set for optimal performance. Contact Machine Solutions for further diagnostics and instructions.

The Autotune function will select the tuning algorithm depending on the stability of current process and the error difference between current process and the Control Setpoint (SP1). If the process is relatively stable (i.e: at room temperature), a bump test will be performed to determine the plant characteristics.







If the process is hot, or if the process is within 10% of Control Setpoint, limit cycle oscillation will be performed with the tuning setpoint taken at the process value when the Autotune function is triggered. Autotuning may be performed as many times as needed or when the operating conditions (i.e: process load, or setpoint) have changed significantly. To obtain good tuning results, ensure the process is stable prior to triggering autotune function. The process is stable when it is at ambient temperature, or it is tracking Control Setpoint (SP1) in auto mode.

Note: Ensure the temperature is at room temperature prior to starting the Auto Tune process.

Use the PRoG (Programming Mode) Menu for Steps 1-7









1. Setpoint 1 Configuration (PRoG > SP1 > #)

Level 2	Level 3	Level 4	Level 5	Level 6	Level 7	Level 8	Notes
SP1	_____						Process goal for PID

	Note: If not at Level 1, push the  button to get to that level.
	Level 1 = INIt, PRoG, and oPER
	Navigate to PRoG (Programming Mode).
	Select PRoG .
	Navigate to SP1 (Setpoint 1 parameter).
	Select the SP1 .
	Set the process goal value.
	Confirm the value.







2. (PRoG> PId > A.to > 5.00)

Level 2	Level 3	Level 4	Level 5	Level 6	Level 7	Level 8	Notes
PId	A.to	5.00					Set timeout time for autotune

	Note: If not at Level 1, push the  button to get to that level.
	Level 1 = INIt, PRoG, and oPER
	Navigate to PRoG (Programming Mode).
	Select PRoG .
	Navigate to PId .
	Select PId .
	Navigate to A.to .
	Select A.to
	Set to 5.00 minutes or above

3. (PRoG> PId > GAIN > _P_ > 2.77)

Level 2	Level 3	Level 4	Level 5	Level 6	Level 7	Level 8	Notes
PId	GAIN	_P_	2.77				Manual Proportional Band setting

	Navigate back to level 3 by pushing the  button.
	Navigate to GAIN .
	Select GAIN .
	Navigate to _P_
	Select _P_
	Enter 2.77

4. (PRoG > PId > GAIN > _I_ > 0.08)

Level 2	Level 3	Level 4	Level 5	Level 6	Level 7	Level 8	Notes
PId	GAIN	_I_	0.08				Manual Integral Factor setting

	Navigate to _I_
	Select _I_
	Enter 0.08





5. (PRoG> PId > GAIN > _d_ > 23.87)

Level 2	Level 3	Level 4	Level 5	Level 6	Level 7	Level 8	Notes
PId	GAIN	_d_	23.87				Manual Derivative Factor setting

	Navigate to _d_
	Select _d_
	Enter 23.87

6. (PRoG > PId > AdPt > ENbL)





Level 2	Level 3	Level 4	Level 5	Level 6	Level 7	Level 8	Notes
PId	AdPt	ENbL					Enable fuzzy logic adaptive tuning

	Navigate back to level 3 by pushing the  button.
	Navigate to AdPt
	Select AdPt
	Navigate to ENbL
	Select ENbL

To Begin AutoTune

7. (PRoG > PId > tUNE > StRt)













Level 2	Level 3	Level 4	Level 5	Level 6	Level 7	Level 8	Notes
PId	tUNE	StRt					Enable fuzzy logic adaptive tuning

	Navigate back to level 3 by pushing the  button.
	Navigate to tUNE
	Select tUNE
	Select StRt
	Auto Tune starts and displays DONE when completed

Changing Temperature Units on the Temperature Controller

Use Initialization Mode (INIT > RdG > °F °C > °F)







Level 2	Level 3	Level 4	Level 5	Level 6	Level 7	Level 8	Notes
RdG	°F°C	°F					

	<p>Note: If not at Level 1, push the  button to get to that level.</p> <p>Level 1 = INIT, PRoG, and oPER</p>
	Navigate to INIT (Initialization Mode).
	Select INIT .
	Navigate to RdG (Reading Formats).
	Select RdG .
	Navigate to °F°C (Temperature Units).
	Select °F°C .
	Navigate to °F
	Select °F
	Select up button to go back to level 1
	Navigate to oPER
	Select oPER
	"RUN" will be displayed.
	Back to temperature readout and normal operating status.

Resetting the Temperature Controller(s) back to factory defaults.

To reset the Omega controller to factory defaults, enter the INIt (Initialization Mode) Menu and follow the steps below.

Level 2	Level 3	Level 4	Level 5	Level 6	Level 7	Level 8	Notes
F.dFt	ok?						ENTER resets to factory defaults













	Note: If not at Level 1, push the  button to get to that level. Level 1 = INIt, PRoG, and oPER
	Navigate to INIt (Initialization Mode).
	Select INIt .
	Navigate to F.dFt
	Select F.dFt
	Navigate to ok?
	Select ok?
	The controller will now be reset. Next, enter the following MSI settings in red.

Resetting the Temperature Controller(s) back to MSI settings.

Use Initialization Mode to set the following parameters 1-7.













1. Thermocouple Input Type (INIt > INPt > t.C. > k)

Level 2	Level 3	Level 4	Level 5	Level 6	Level 7	Level 8	Notes
INPt	t.C.	k					Type K thermocouple

	Note: If not at Level 1, push the  button to get to that level. Level 1 = INIt, PRoG, and oPER
 	Navigate to INIt (Initialization Mode).
	Select INIt .
 	Navigate to INPt (Input parameter).
	Select INPt .
 	Navigate to t.C. (thermocouple).
	Select t.C.
 	Navigate to the K thermocouple type.
	Select k .













2. Decimal Point Format (INIt > RdG > dEC.P > FFF.F)

Level 2	Level 3	Level 4	Level 5	Level 6	Level 7	Level 8	Notes
RdG	dEC.P	FFF.F					Reading format -999.9 to +999.9

	Note: If not at Level 1, push the  button to get to that level. Level 1 = INIt, PRoG, and oPER
 	Navigate to INIt (Initialization Mode).
	Select INIt .
 	Navigate to RdG (Reading Formats).
	Select RdG .
 	Navigate to dEC.P (Decimal-point Format).
	Select dEC.P .
 	Navigate to FFF.F (One decimal place).
	Select FFF.F .













3. Temperature Units (INIt > RdG > °F°C > °C)

Level 2	Level 3	Level 4	Level 5	Level 6	Level 7	Level 8	Notes
RdG	°F°C	°C					Degrees Celsius annunciator

	<p>Note: If not at Level 1, push the  button to get to that level.</p> <p>Level 1 = INIt, PRoG, and oPER</p>
 	Navigate to INIt (Initialization Mode).
	Select INIt .
 	Navigate to RdG (Reading Formats).
	Select RdG .
 	Navigate to °F°C (Temperature Units).
	<ul style="list-style-type: none"> • °C - Degrees Celsius (factory default), °C annunciator turned on • °F - Degrees Fahrenheit, °F annunciator turned on
	Select °F°C .
 	Navigate to °C
	Select °C













4. Filter (INIt > RdG > FLtR > 8)

Level 2	Level 3	Level 4	Level 5	Level 6	Level 7	Level 8	Notes
RdG	FLtR	8					Readings per displayed value: 8

	<p>Note: If not at Level 1, push the  button to get to that level.</p> <p>Level 1 = INIt, PRoG, and oPER</p>
 	Navigate to INIt (Initialization Mode).
	Select INIt .
 	Navigate to RdG (Reading Formats).
	Select RdG .
 	Navigate to the FLtR (Filter parameter).
	Select FLtR .
 	Navigate to 8 (0.4 s).
	Select 8 .













5. Normal Color (INIt > RdG > NCLR > GRN)

Level 2	Level 3	Level 4	Level 5	Level 6	Level 7	Level 8	Notes
RdG	NCLR	GRN					Default display color: Green

	<p>Note: If not at Level 1, push the  button to get to that level.</p> <p>Level 1 = INIt, PRoG, and oPER</p>
 	Navigate to INIt (Initialization Mode).
	Select INIt .
 	Navigate to RdG (Reading Formats).
	Select RdG .
 	Navigate to NCLR (Normal Color parameter).
	Select NCLR .
 	Navigate to GRN (Green) .
	Select GRN .









6. Brightness (INIt > RdG > bRGt > HIGH) Brightness setting = HIGH

Level 2	Level 3	Level 4	Level 5	Level 6	Level 7	Level 8	Notes
RdG	bRGt	HIGH					High display brightness

	<p>Note: If not at Level 1, push the  button to get to that level.</p> <p>Level 1 = INIt, PRoG, and oPER</p>
 	Navigate to INIt (Initialization Mode).
	Select INIt .
 	Navigate to RdG (Reading Formats).
	Select RdG .
 	Navigate to bRGt (Brightness parameter).
	Select bRGt .
 	Navigate to HIGH (High display brightness).
	Select HIGH .

7. Safety Features (INIt > SFty > PwoN > RSM)

Level 2	Level 3	Level 4	Level 5	Level 6	Level 7	Level 8	Notes
SFty	PwoN	RSM					RUN on power up if not previously faulted

	<p>Note: If not at Level 1, push the  button to get to that level.</p> <p>Level 1 = INIt, PRoG, and oPER</p>
	Navigate to INIt (Initialization Mode).
	Select INIt .
	Navigate to SFty (Safety Features).
	Select SFty .
	Navigate to PwoN (Power On Confirmation parameter).
	Note: PwoN – Requires confirmation before running automatically at startup
	Select PwoN .
	Navigate to RSM .
	Note: RSM – Program runs automatically at startup if not previously in fault state.
	Select RSM .











8. Configure the USB port

CoMM	USb						Configure the USB port
------	-----	--	--	--	--	--	------------------------

Use Programming Mode (PRoG) to set the following parameters 9-14.

9. Setpoint 1 Configuration (PRoG > SP1 > #)







Level 2	Level 3	Level 4	Level 5	Level 6	Level 7	Level 8	Notes
SP1	_____						Process goal for PID

	Note: If not at Level 1, push the  button to get to that level. Level 1 = INIt, PRoG, and oPER
 	Navigate to PRoG (Programming Mode).
	Select PRoG .
 	Navigate to SP1 (Setpoint 1 parameter).
	Select the SP1 .
 	Set the process goal value.
	Confirm the value.

Sections 10-12 are set for all models except 220B, 320B, 43B, and TF-120
For models 220B, 320B, 43B, and TF-120 skip to Section 13

10. Alarm High/Low setting (PRoG > ALM.1, ALM.2 > type > HI.Lo)

Level 2	Level 3	Level 4	Level 5	Level 6	Level 7	Level 8	Notes
ALM.1	Note: This submenu is the same for all other Alarm configurations.						
	tyPE						
		HI.Lo.					Alarm: process value outside Alarm triggers

	Note: If not at Level 1, push the  button to get to that level. Level 1 = INIt, PRoG, and oPER
 	Navigate to PRoG (Programming Mode).
	Select PRoG .
 	Navigate to ALM.1 (Alarm Configuration 1). Note: Select Alarm Configuration to set up, change, enable, or disable Alarms. Either or both Alarms can be assigned to trigger display color changes, annunciators, and / or outputs. Either or both Alarm configurations can be assigned to multiple outputs. The ALM.1 and ALM.2 configuration menus have all the same settings and function in the same manner.
	Select ALM.1 .

	Navigate to tyPE (Alarm Type Parameter). Note: This parameter will control the basic behavior of the selected alarm.
	Select tyPE .
	Navigate to HILO
	Select HILO

11. Alarm high, low, color reference parameters

Level 2	Level 3	Level 4	Level 5	Level 6	Level 7	Level 8	Notes
ALM.1	ALR.H	<u>2.5</u>					Alarm high parameter for trigger calculations
ALM.1	ALR.L	<u>2.5</u>					Alarm low parameter for trigger calculations
ALM.1	A.CLR	REd					Red display when Alarm is active

Alarm High Reference (PRoG > ALM.1 > ALR.H)

	Follow Steps in Section 10. Note: After selecting HI.Lo setting, tyPE parameter should be showing in window.
	Navigate to ALR.H (Alarm High Reference parameter).
	Select ALR.H .
	Set the Alarm High Reference value = 2.5 Note: One arrow moves the digit and the other moves the value.
	Confirm the value.

Alarm Low Reference (PRoG > ALM.1 > ALR.L)









	Follow Steps in Section 10. Note: After selecting HI.Lo setting, tyPE parameter should be showing in window.
	Navigate to ALR.L (Alarm Low Reference parameter).
	Select ALR.L .
	Set the Alarm Low Reference value = 2.5 Note: One arrow moves the digit and the other moves the value.
	Confirm the value.

Alarm Color (PRoG > ALM.1 > A.CLR > REd)

	Follow Steps in Section 10. Note: After selecting HI.Lo setting, tyPE parameter should be showing in window.
	Navigate to A.CLR (Alarm Color parameter).
	Select A.CLR .
	Navigate to REd (Alarm conditions are displayed in red).
	Select the REd .

12. Output as Alarm 1 (PRoG > dtR1 > ModE > ALM.1)













Level 2	Level 3	Level 4	Level 5	Level 6	Level 7	Level 8	Notes
dtR.1							dtR.1 is replaced by output type. For example: oUt#
	ModE		Note: This submenu is the same for all other outputs.				
		ALM.1					Output is an Alarm using ALM.1 configuration

	Note: If not at Level 1, push the  button to get to that level. Level 1 = INIt, PRoG, and oPER
	Navigate to PRoG (Programming Mode).
	Select PRoG .
	Navigate to dtR1 (Double Throw Mechanical Relay number 1). Note: All output channels have the same menu structure. However, only those parameters that apply for the type of output being configured appear in that output's menu.
	Select dtR1 .
	Navigate to ModE . Note: ModE – Allows the output to be set up as a control, Alarm, retransmission, or Ramp/Soak event output; the output can also be turned off.
	Select ModE .
	Navigate to ALM.1 . Note: ALM.1 – Set the output to be an Alarm using the ALM.1 configuration
	Select ALM.1 .

Section 13 is for Models 220B, 320B, 43B, and TF-120









13. Turn Off Output Channel (PRoG > dtR1 > ModE > oFF)

Level 2	Level 3	Level 4	Level 5	Level 6	Level 7	Level 8	Notes
dtR.1	ModE	oFF					Output does nothing

	<p>Note: If not at Level 1, push the  button to get to that level.</p> <p>Level 1 = INIt, PRoG, and oPER</p>
 	Navigate to PRoG (Programming Mode).
	Select PRoG .
 	Navigate to dtR1 (Double Throw Mechanical Relay number 1). Note: All output channels have the same menu structure. However, only those parameters that apply for the type of output being configured appear in that output's menu.
 	Navigate to ModE . Note: ModE – Allows the output to be set up as a control, Alarm, retransmission, or Ramp/Soak event output; the output can also be turned off.
	Select ModE .
 	Navigate to oFF . Note: oFF – Turn off the output channel
	Select oFF .









14. PID Control Mode (PRoG > dc.1 > ModE > PId)

Level 2	Level 3	Level 4	Level 5	Level 6	Level 7	Level 8	Notes
dc.1							dc.1 is replaced by output type. For example: oUt#
	ModE						
		PId					PID Control Mode

	<p>Note: If not at Level 1, push the  button to get to that level.</p> <p>Level 1 = INIt, PRoG, and oPER</p>
	Navigate to PRoG (Programming Mode).
	Select PRoG .
	Navigate to dc1 (DC Pulse output number 1). Note: All output channels have the same menu structure. However, only those parameters that apply for the type of output being configured appear in that output's menu.
	Select dc1 .
	Navigate to ModE . Note: ModE – Allows the output to be set up as a control, Alarm, retransmission, or Ramp/Soak event output; the output can also be turned off.
	Select ModE .
	Navigate to PId . Note: PId - Set the output to Proportional-Integral-Derivative (PID) Control Mode.
	Select PId .

15. Increase to SP1 (PRoG > PLD > ACtN > RVRS)

Level 2	Level 3	Level 4	Level 5	Level 6	Level 7	Level 8	Notes
Pld	ACtN	RVRS					Increase to SP1 (i.e., heating)

	<p>Note: If not at Level 1, push the  button to get to that level.</p> <p>Level 1 = INIt, PRoG, and oPER</p>
	Navigate to PRoG (Programming Mode).
	Select PRoG .
	Navigate to Pld .
	Note: Pld – Set the output to Proportional-Integral-Derivative (PID) Control Mode
	Select Pld .
	Navigate to ACtN .
	Note: ACtN – Determines the action direction for control
	Select ACtN .
	Navigate to RVRS .
	Note: RVRS – Off when Process Value is > Setpoint, and on when Process Value is < Setpoint (e.g., heating); deadband is applied below Setpoint (factory default)
	Select RVRS .

A full description of features can be found here: <https://assets.omega.com/manuals/M5451.pdf>.

APPENDIX B

Die Head Sizing

- Description:** This procedure describes the process of sizing the Thermal Die Head tooling used on Beahm Bonders (model #'s 220B, 320B, 420B, 520B & 620B)
- Scope:** This document applies to Part # 3054593-001, and 3052819-001 (only applies to 520B and 620B) Thermal Die Heads
- Tools and Equipment:** Caliper or micrometer
- Reference:** Figure B-1. Die Head Sizing
- Procedure:**
1. Assemble components to be bonded over mandrel(s) (Refer to Figure B-1, Steps 1-2).
 2. Measure bond length, tubing overlap, balloon sleeve length (Refer to Figure B-1, Steps 1-3).
 3. Position protective sleeve (fitted PTFE, PET heat shrink, or Polyolefin heat shrink) over bond location (Refer to
 4. Figure B-1. Die Head Sizing Steps 1-4).
 5. For heat shrink sleeves (PET, Polyolefin etc.) shrink the sleeve onto the bond location.
 6. Measure O.D. of protective sleeve at bond location (Refer to
 7. Figure B-1. Die Head Sizing Steps 1-5).
 8. Machine the die heads to width based on the value in Step 2.
 9. Bore hole through heads .003" less than diameter value in Step 4.
 10. For Balloon Shield bore size add .005" to the product OD (without sleeve).

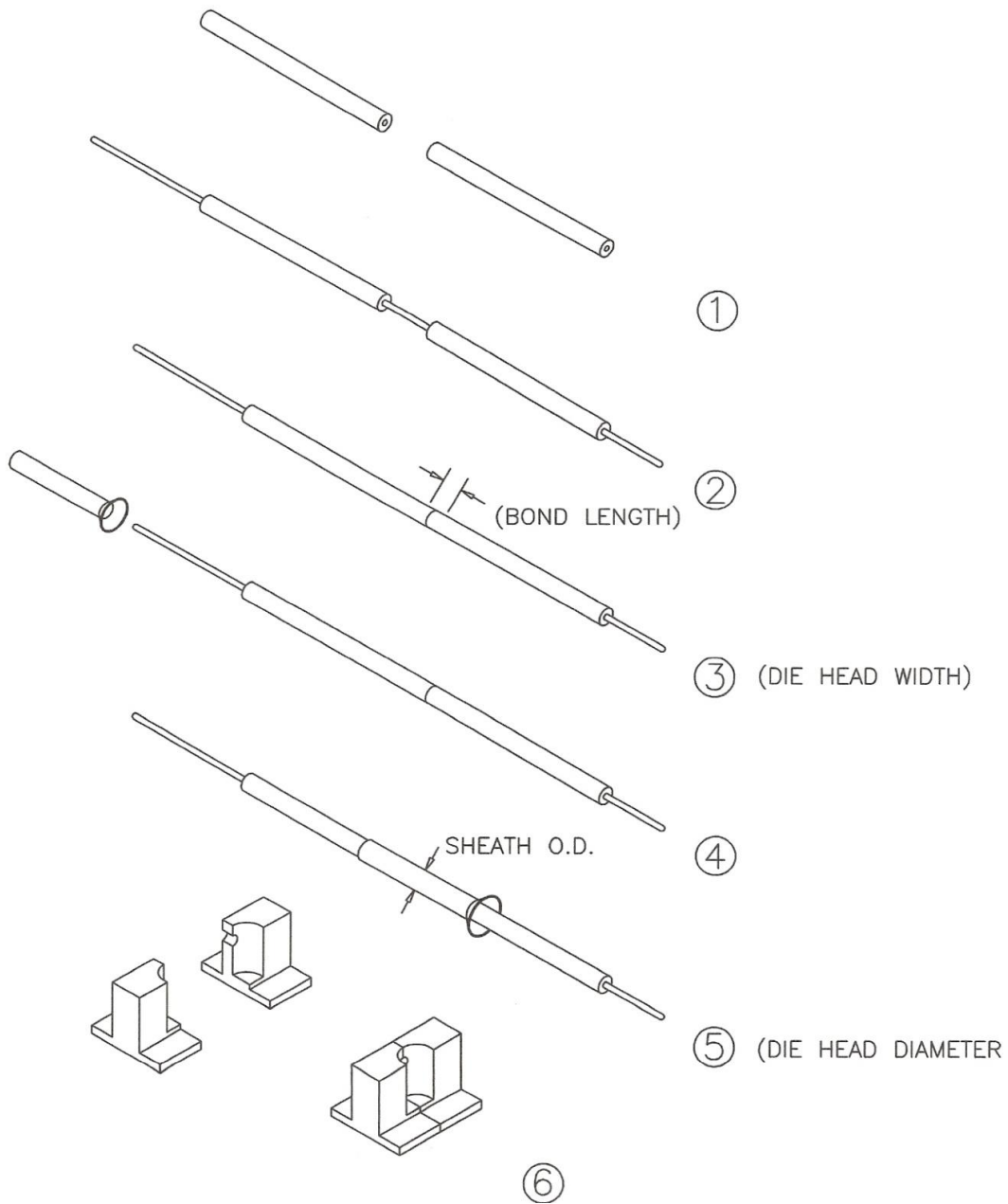

Figure B-1. Die Head Sizing